



Application Note

Use of the FlexyPlant in process development

The requirement was to install a universal scale-up reactor with a working volume of 20 litres in a process technology department. The client required the following additional characteristics:

- ⇒ Pressure range from -1 to 10 bar
- ⇒ Usable as a normal pressure reactor -1 to 0.5 bar (reflux) and as a pressure reactor 0 to 12 bar
- ⇒ Control of temperature, pH, pressure and two metered inputs from weighing machines, at up to 10 bar back-pressure
- ⇒ Metered input of hydrogen
- ⇒ EEx-rated construction

Challenges

- ⇒ The client should only need to communicate with a single contact person, although key components (heating-cooling / reactor / automation) are to be supplied by three different manufacturers.
- ⇒ The reactor should be available to all the staff of the process technology department, so it must be possible to operate the plant without long familiarisation times.
- ⇒ Because “inexperienced” users will also be using the reactor, safety-critical operations (inerting, hydrogen gas exchange) must be automated without, however, limiting the plant’s flexibility.

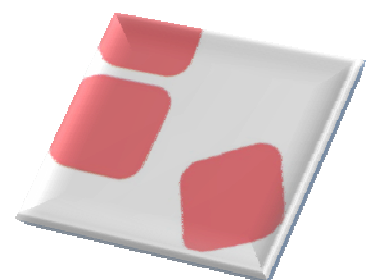

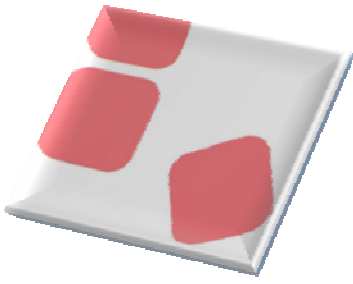

Description of the solution

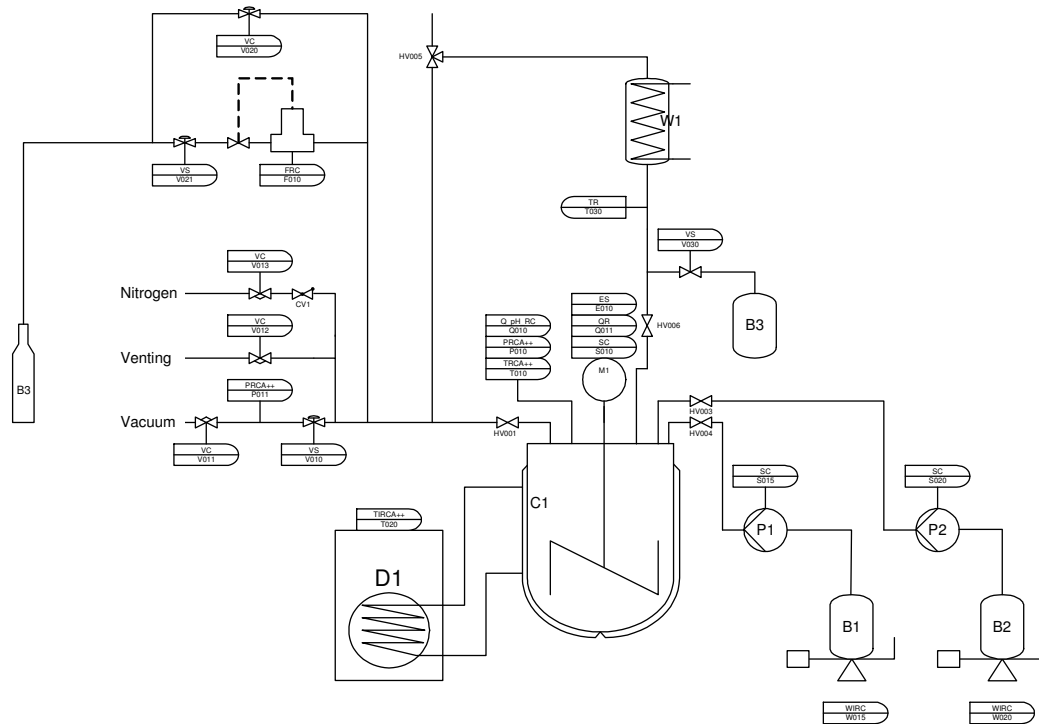

The above piping and instrumentation diagram shows how the client's requirements were implemented. SYSTAG's experience over many years is reflected in a few small but important details:

- ⇒ The hydrogen input pipe can go either via a bypass or through the flowmeter. The bypass is used to carry out the gas changeover from nitrogen to hydrogen at the start of the hydrogenation quickly and without the flowmeter's restrictions. This allows a relatively small measuring range to be chosen for the flowmeter, which enables precise, sensitive detection of the hydrogen absorption end-point.
- ⇒ The reactor is fitted with two pressure sensors. This enables the pressure for distillations to be measured with millibar accuracy. An automatically closing valve protects the low pressure sensor from overloads.
- ⇒ The same valve also has a safety function: it prevents the hydrogen-filled reactor being vented via the vacuum pump.

The plant was implemented through a proven network of partner companies with whom SYSTAG has already collaborated for many years. Since each participant in the network of suppliers is familiar with their partner's products, there are no delays and no costly modifications at the interfaces.

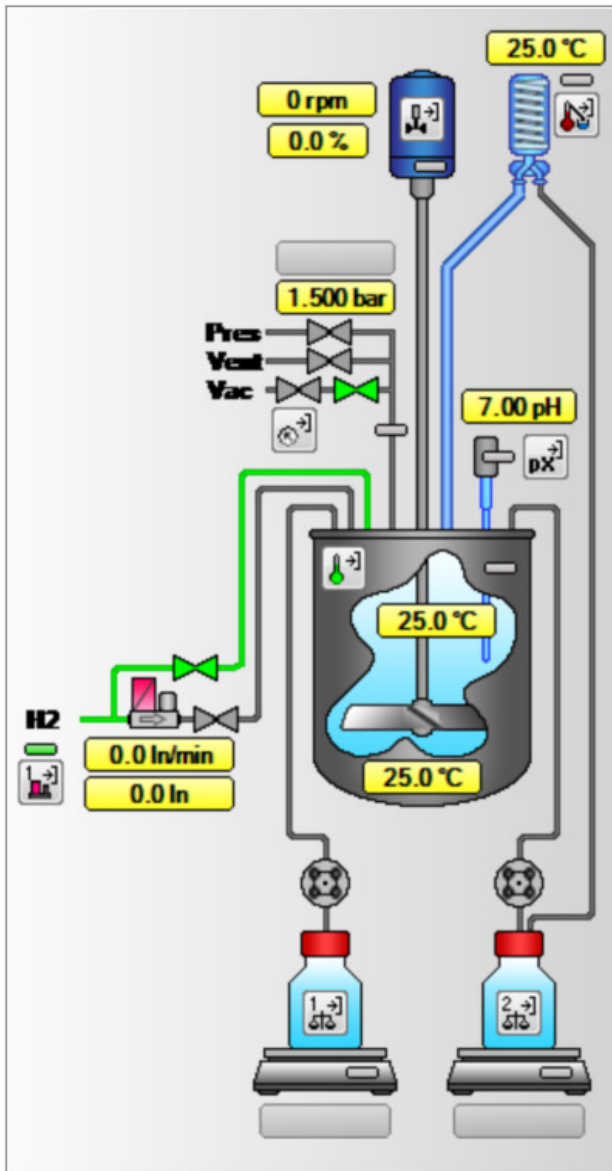
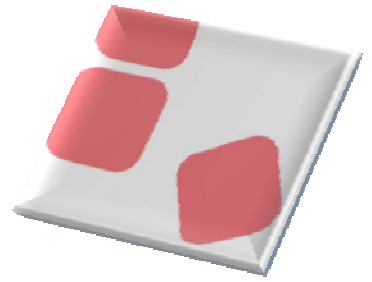

Systag intentionally avoids “technically correct” flow diagrams, choosing instead to use representations of the individual reactor components that are as close to reality as possible. The user should be able to recognise the individual equipments on the screen and should thus be able to operate the plant correctly by intuition.

Integrated animations and colour scheme enable the correct assessment of the reactor state at a glance.

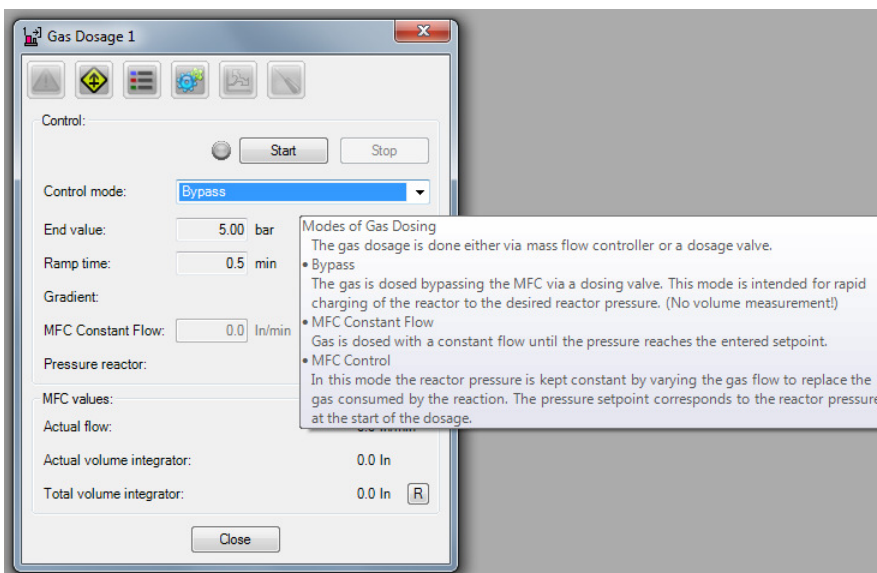

The adjustable parameters for each operation are presented in an easily understandable way in an operating window.

Further explanations for each parameter can be displayed via the built-in “tooltips”.

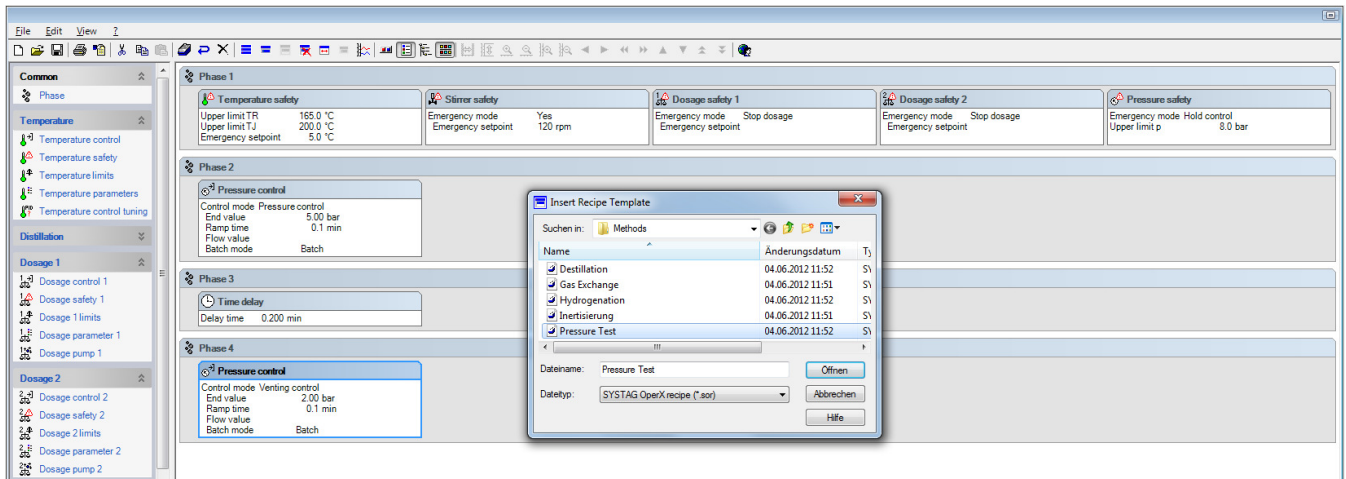
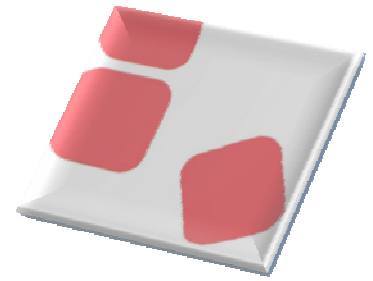

Recipes are set by simply dragging and dropping the individual operations into defined recipe phases. Critical sequences such as inerting or leak tests can be combined into pre-defined methods, thus making them available to every user for his/her recipes.

Summary

Thanks to a proven network of suppliers, SYSTAG supplies you with turnkey plants for scale-up and small-scale production. The "FlexySys" control software used enables even personnel who are not specially trained to operate the plant safely and efficiently. SYSTAG's plants are characterised by their highly flexible hardware and software, which ensure that future tasks can be processed without the need for major modifications.